

Section 184, Highways Act 1980;
Vehicle crossings over footways and verges**Guidance notes & procedure****Contents**

Checklist	2
Procedure and Conditions	4
Application Form Guidance	5
Standard Construction Details.....	7

Checklist:

Below are a number of questions that you need to consider when applying for a vehicle crossing. Please note that any issues identified may result in considerable additional cost being incurred or the application being refused:

- 1) Is the crossing required as part of an existing planning application?**
If yes, please quote the planning application number on your vehicle crossing application.
- 2) Will you require planning permission?**
You will usually require planning permission if the new or altered access is onto a classified road or if the proposal is not a permitted development. A hard standing must be constructed of a permeable material or provided to direct run-off water to a permeable area within the curtilage of the property to be considered permitted development. Highways can advise on the classification of the road via the email at the end of this document; Monmouthshire County Council's Planning department can advise on permitted developments. Tel: 01633 644880 Email: planning@monmouthshire.gov.uk
- 3) Do you have an existing vehicle crossing?**
If you intend to build another crossing to the property or extend an existing one, you will still need permission.
Generally only one crossing will be considered into a property. Separate "In and Out" and excessively wide crossings will not be permitted where they reduce available parking to residents and compromise road safety.
In quiet cul de sacs, residential roads with little used footways, where highway safety will not be compromised, a second crossing or widening of an existing access may be permitted.
- 4) Do you have at least 5.0m of length for a hard standing?**
If you do not have at least 5m of useable space to park a vehicle (*this measurement to be taken between the highway boundary i.e. rear of footway and the face of the building*) your application may be refused.
If you intend to have gates this distance will need to be longer as gates are required to open inwards.
- 5) Do you live close to a junction?**
How close are you to a junction with another street/road, if less than 10m this may be a problem.
- 6) Do you live close to a bus stop?**
If you wish to construct a crossing where there is an existing bus stop, you may have to pay to relocate the raised platform. Please contact the transport department who are responsible for the bus stops in the County who can advise further. Tel: 01633 644947
- 7) Do you have a tree near to where the crossing will be located?**
A tree may be protected by a TPO. You would need to contact the council's tree officer prior to removing the tree or excavating near the tree and roots. Tel: 01633 644962
- 8) Are there any street lighting columns, service covers or other street furniture near to where you want the crossing?**
These can be very costly to move and if Monmouthshire County Council's Street Lighting Section or the Utility Company agrees to re-locate these apparatus or upgrade covers, then you will be expected to pay the costs.
- 9) Do you live in a conservation area?**
If you live in a conservation area then you may require planning permission to remove or alter boundary walls or fences and works within your garden. You should contact the Monmouthshire County Council's Planning department for advice.

10) Are you a tenant of Monmouthshire Housing or housing association or leasehold property?

If you are, you will need the consent of the landlord to construct a hard standing.

11) Will the vehicle crossing need to be constructed by a specific contractor? Yes, you will require an approved contractor. An approved contractor has Streetworks accreditation in accordance with the New Roads and Streetworks Act 1991. Namely they have suitably trained and accredited operatives and supervisors.

The contractor will also have the appropriate level of Public Liability Insurance to a value not less than £5 million.

12) Is there a Fee?

Yes. There is a fee of **£150.00**, which covers the administration and inspection of the vehicular crossing. A cheque can be made payable to Monmouthshire County Council and should be sent with the Notification of Commencement once your application is approved. Alternatively, you can pay by card over the telephone. Please contact us for further information and advice.

Procedure and Conditions:

- 1) If you would still like to pursue an application for the construction of a crossing after reviewing the checklist, please complete and return the Preliminary Application Form to:

Highways Development
Monmouthshire County Council
County Hall
Rhadyr
Usk
NP15 1GA

Or by email to highdev@monmouthshire.gov.uk
- 2) If your application is approved, you will be sent an acceptance letter with the Final Application Form.
- 3) The approval is subject to all material matters remaining unchanged. Approval is in principle and may be revoked if any condition or other relevant particular is changed, and places a duty on the applicant to check if they believe something to arise that may affect their application.
- 4) Further to approval, you and your contractor will need to complete Final Application Form and submit this with the supporting documentation (Insurance liability etc.) to the above address along with the inspection fee and confirmation of date of commencement.
- 5) We require 14 days' notice, prior to commencement of the work. Should there be any issues with providing this notice, please contact us so we can discuss your requirements.
- 6) During construction the Council will inspect the works, with the contractor affording the Council access, and taking instruction if deemed appropriate and necessary by the inspecting engineer.
- 7) If following completion the council are not satisfied with the construction of the vehicular crossing then you will be instructed to rectify any works or defects identified. Please contact us following completion as soon as possible so we can confirm our acceptance.
- 8) Following completion of the vehicle crossing (and defects if required), the crossing will be subject to a 12 month maintenance period and any further works or defects identified in this period will require rectification.
- 9) Failure to adhere to the procedure and satisfactorily complete the works, the Council has the power under section 184(10) of the Highways Act 1980 to arrange for the completion of the works and recover from the applicant any expenses incurred in doing so.
- 10) If your proposal for a vehicle crossing is not acceptable, officers will provide a detailed explanation.
- 11) All applications are considered on their individual merits in accordance with local and national guidelines and in the interest of highway safety. In the event you wish to appeal a decision, you may do so in accordance with the "Footway / Verge Vehicle Crossing - Appeals Procedure"

Application Form Guidance:

Preliminary Application Form (1) – Initial Request:

- 1) If you have any problems or queries regarding your application, please contact us quoting the reference number at:
Email: highdev@monmouthshire.gov.uk
Tel: 01633 644732
- 2) Please complete the application form as accurately as possible, providing additional information, if relevant, to assist officers in determining your application.
- 3) The application form will be used by officers to determine the suitability of your request. The officer determining your application will likely visit the location and, if deemed appropriate, arrange a joint inspection.
- 4) Please submit a copy of the relevant permissions required with your application i.e. from the relevant landlord or Monmouthshire housing association.
- 5) Provide a sketch/drawing to include existing layouts and proposed vehicle crossing, including approximate dimensions if possible. (See example sketch below)
- 6) (Optional) Provide photographs. Although not absolutely necessary, they will assist the officer in determining your application.

Example sketch:

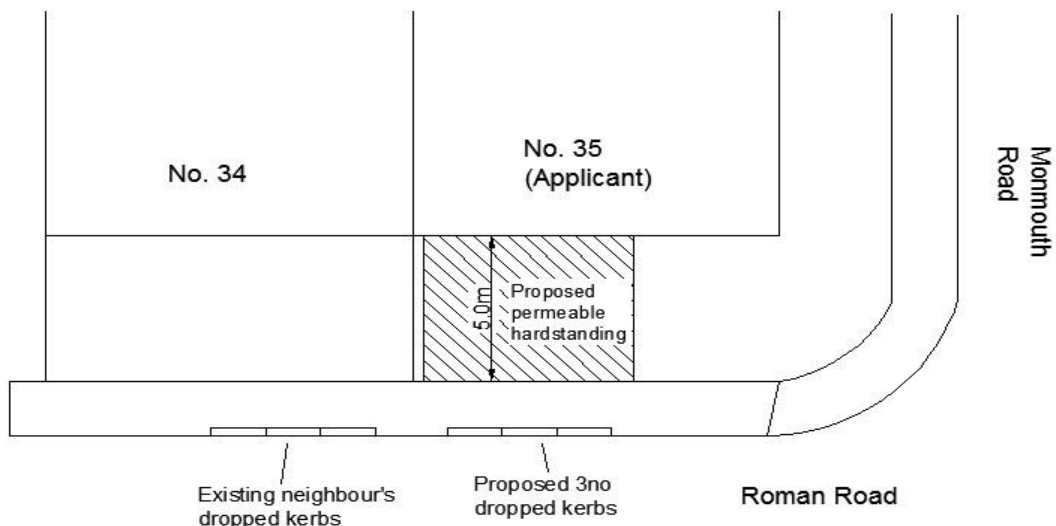

Final Application Form (2):

- 1) Both you and your appointed contractor are required to complete the application form.
- 2) Provide copies of the contractors street works accreditation and insurance liability details with the application.
- 3) The process for constructing a vehicle crossing cannot proceed until this application form is submitted.
- 4) Include payment for the inspection fee.

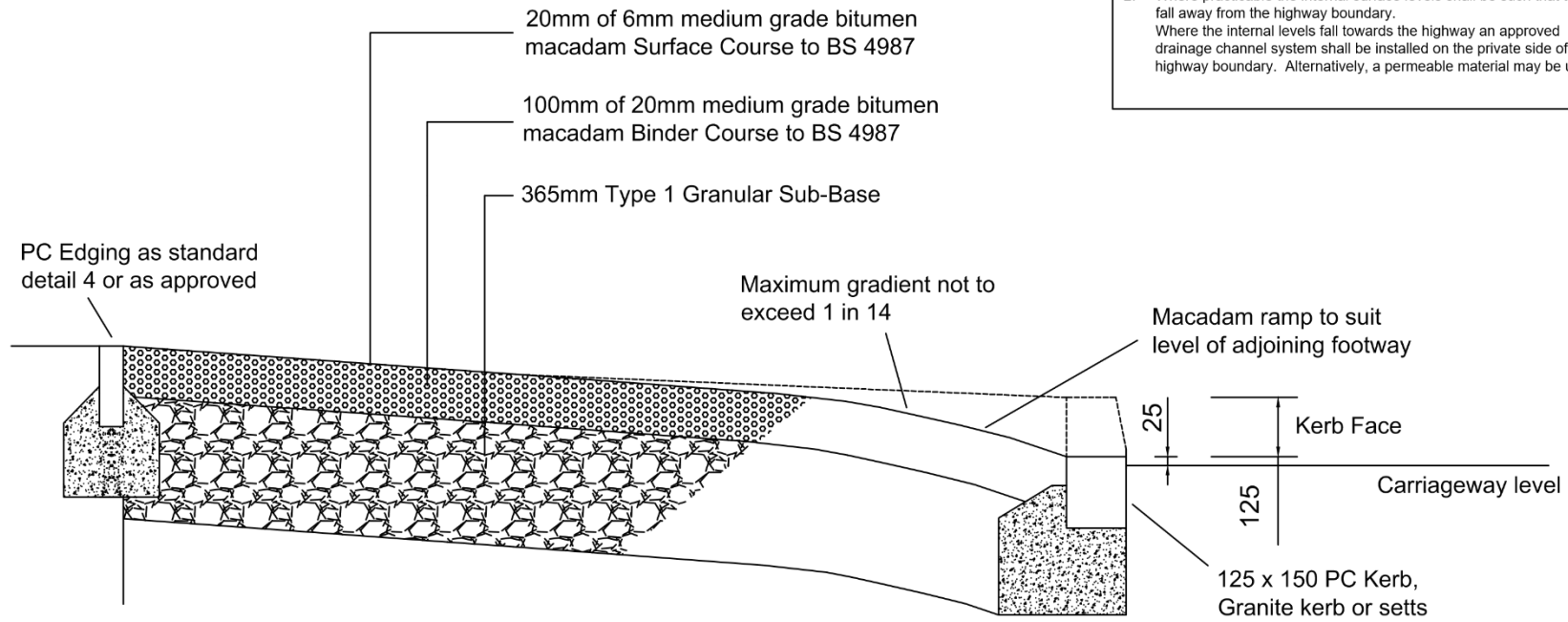

Standard Construction Details:

- NOTES:
1. All dimensions are in millimetres unless otherwise stated
 2. Where practicable the internal surface levels shall be such that they fall away from the highway boundary. Where the internal levels fall towards the highway an approved drainage channel system shall be installed on the private side of the highway boundary. Alternatively, a permeable material may be used.





Footway, at its full width, should continue at even level through gateways

SECTION THROUGH HEAVY DUTY VEHICULAR ACCESS

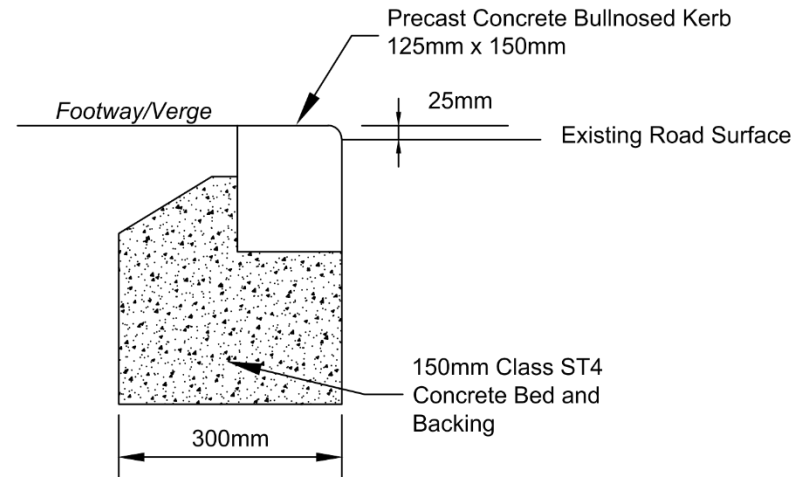
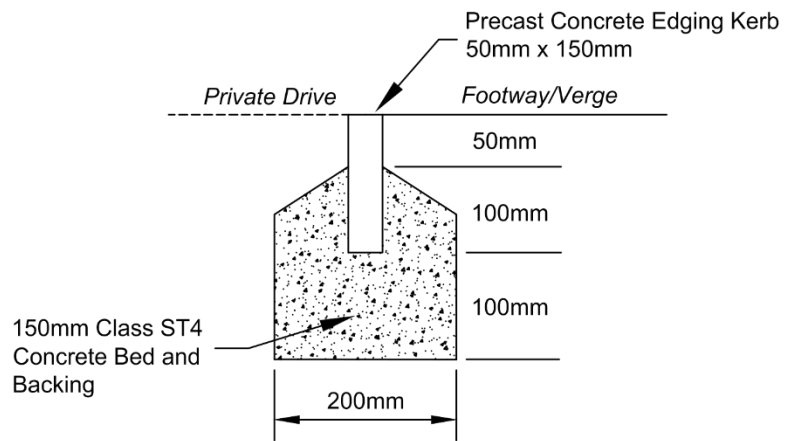
 <p>monmouthshire COUNTY COUNCIL SINCE 1972</p> <p>ROGER HOGGINS HEAD OF REGENERATION AND CULTURE</p>	<p>Job Title</p> <p>Typical Vehicle Crossing detail</p>	<p>Drawn By</p> <p>CJ</p>	<p>Checked</p> <p>MD</p>	<p>Drawing No.</p>	 <p>Rev</p> <p>A</p>
	<p>Drawing Title</p> <p>Standard Detail 3 - Heavy Duty Vehicle Crossing</p>	<p>Scale</p> <p>NTS</p>	<p>Date</p> <p>17/11/2014</p>	<p>UNAUTHORISED REPRODUCTION INFRINGES CROWN COPYRIGHT AND MAY LEAD TO PROSECUTION OR CIVIL PROCEEDINGS. MONMOUTHSHIRE COUNTY COUNCIL LA09012L2000</p>	



PC Edging and Kerb details

 <p>ROGER HOGGINS HEAD OF REGENERATION AND CULTURE</p>	Job Title Typical Vehicle Crossing detail	Drawn By CJ	Checked MD	Drawing No.	
	Drawing Title Standard Detail 4 - Kerb sections and detail	Scale NTS	Date 17/11/2014	<small>UNAUTHORISED REPRODUCTION INFRINGES CROWN COPYRIGHT AND MAY LEAD TO PROSECUTION OR CIVIL PROCEEDINGS. MONMOUTHSHIRE COUNTY COUNCIL (A05012).2009</small>	

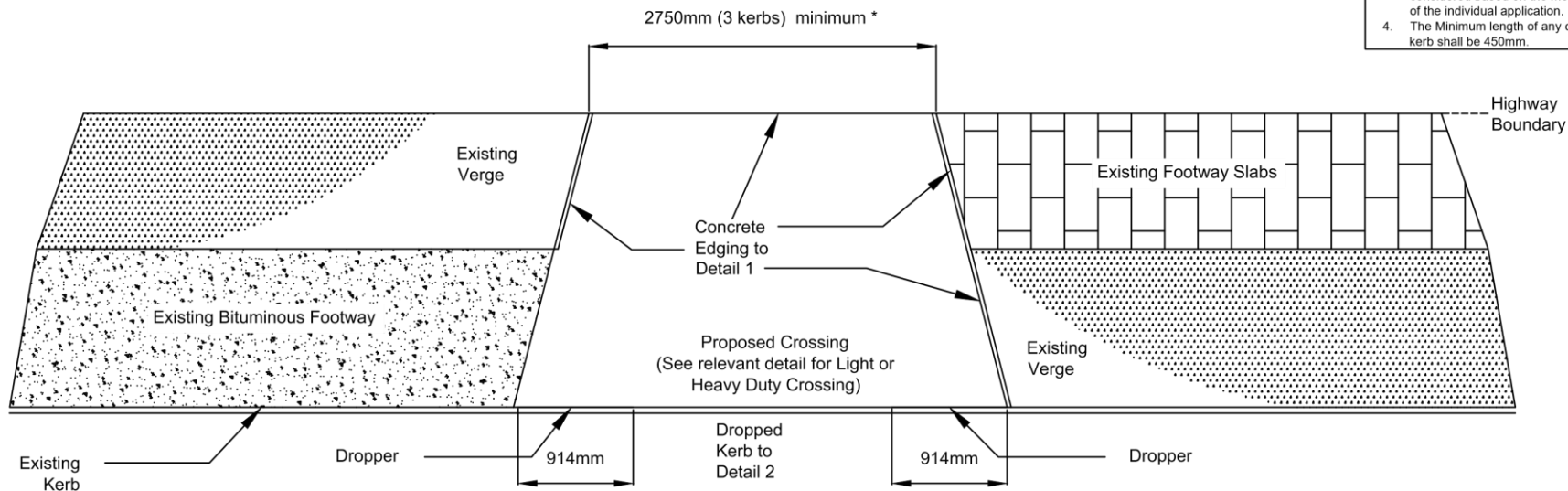

NOTES:

1. All dimensions are in millimetres unless otherwise stated
2. Where practicable the internal surface levels shall be such that they fall away from the highway boundary. Where the internal hard standing falls towards the highway an approved drainage channel system shall be installed on the private side of the highway boundary. Alternatively, a permeable material can be used.
3. Widths greater than 2750 (3 kerbs) are generally not acceptable, but will be considered based on the merit of the individual application.
4. The Minimum length of any cut kerb shall be 450mm.





Surface types

Rev A: Note 4 added
Rev B: Updated

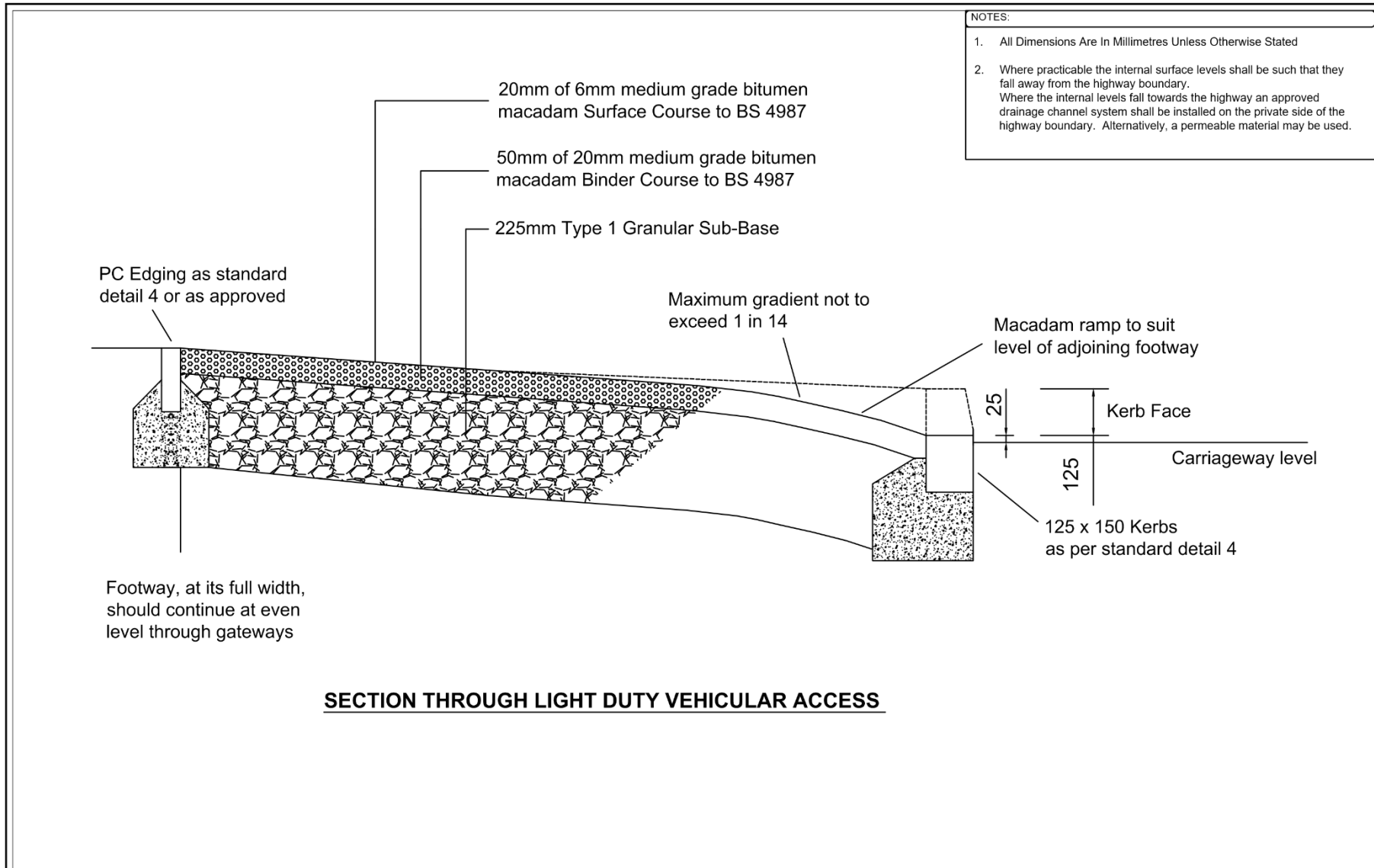
 <p>monmouthshire COUNTY COUNCIL SINCE 1972</p> <p>ROGER HOGGINS HEAD OF REGENERATION AND CULTURE</p>	<p>Job Title Typical Vehicle Crossing detail</p>	<p>Drawn By CJ</p>	<p>Checked MD</p>	<p>Drawing No.</p>	
	<p>Drawing Title Standard Detail 1 - Typical Vehicle Crossing</p>	<p>Scale NTS</p>	<p>Date 17/11/2014</p>	<p>UNAUTHORISED REPRODUCTION INFRINGES CROWN COPYRIGHT AND MAY LEAD TO PROSECUTION OR CIVIL PROCEEDINGS. MONMOUTHSHIRE COUNTY COUNCIL LA09012L2000</p>	



- NOTES:
1. All Dimensions Are In Millimetres Unless Otherwise Stated
 2. Where practicable the internal surface levels shall be such that they fall away from the highway boundary. Where the internal levels fall towards the highway an approved drainage channel system shall be installed on the private side of the highway boundary. Alternatively, a permeable material may be used.

 <p>monmouthshire COUNTY COUNCIL 1897</p> <p>ROGER HOGGINS HEAD OF REGENERATION AND CULTURE</p>	Job Title Typical Vehicle Crossing detail	Drawn By CJ	Checked MD	Drawing No.	
	Drawing Title Standard Detail 2 - Light Vehicle Crossing	Scale NTS	Date 17/11/2014	<small>UNAUTHORISED REPRODUCTION INFRINGES CROWN COPYRIGHT AND MAY LEAD TO PROSECUTION OR CIVIL PROCEEDINGS. MONMOUTHSHIRE COUNTY COUNCIL LA69012L2000</small>	